











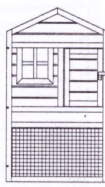
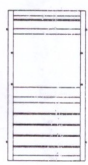
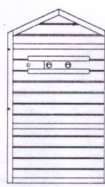
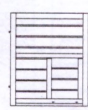
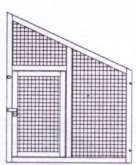

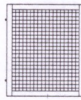
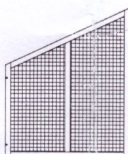
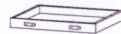

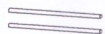



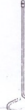

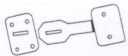

Aufbauanleitung

145

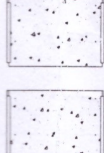
<p>A  M3.5X60=6+1 Stück</p> <p>B  M3.5X45=14+1 Stück</p>	<p>1  1 Stück</p>	<p>2  1 Stück</p>	<p>3  1 Stück</p>	<p>4  1 Stück</p>	<p>5  1 Stück</p>
<p>C  M3.5X35=12+1 Stück</p> <p>D  M3.5X25=4+1 Stück</p>	<p>6  1 Stück</p>	<p>7  1 Stück</p>	<p>8  1 Stück</p>	<p>9  1 Stück</p>	<p>10  1 Stück</p>
<p>E  M3.0X16=14+1 Stück</p> <p>F  M6X50=8+1 Stück</p>	<p>11  1 Stück</p>	<p>12  1 Stück</p>	<p>13  1 Stück</p>	<p>14  1 Stück</p>	<p>15  1 Stück</p>
<p>G  M3.0X15=1 Stück</p> <p> X2 Stück</p> <p> X1 Stück</p>	<p>16  1 Stück</p>	<p>17  1 Stück</p>	<p>18  1 Stück</p>	<p>19  1 Stück</p>	<p>20  1 Stück</p>

Schritt 1:

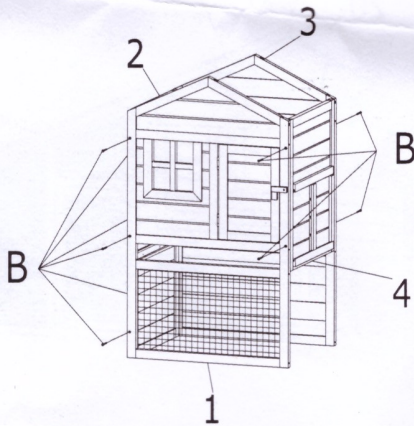

Schritt 2:

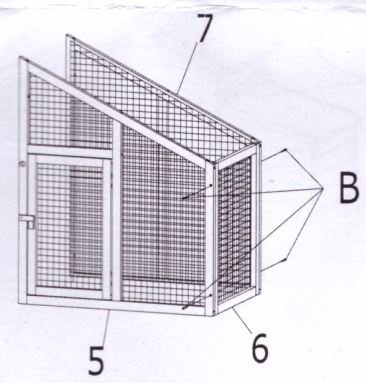

Schritt 3:

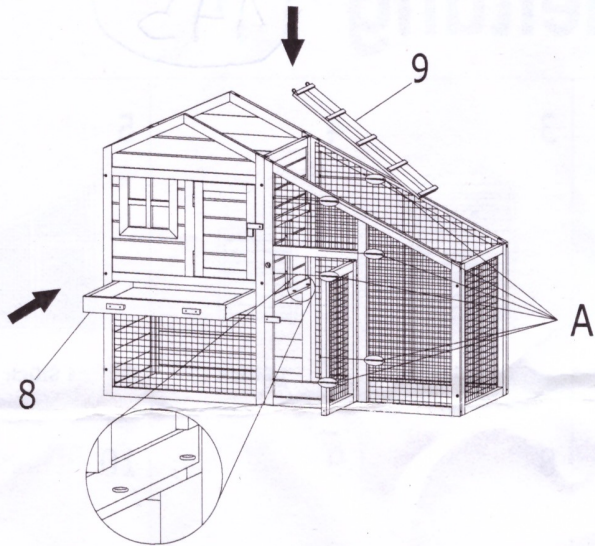

Schritt 4:

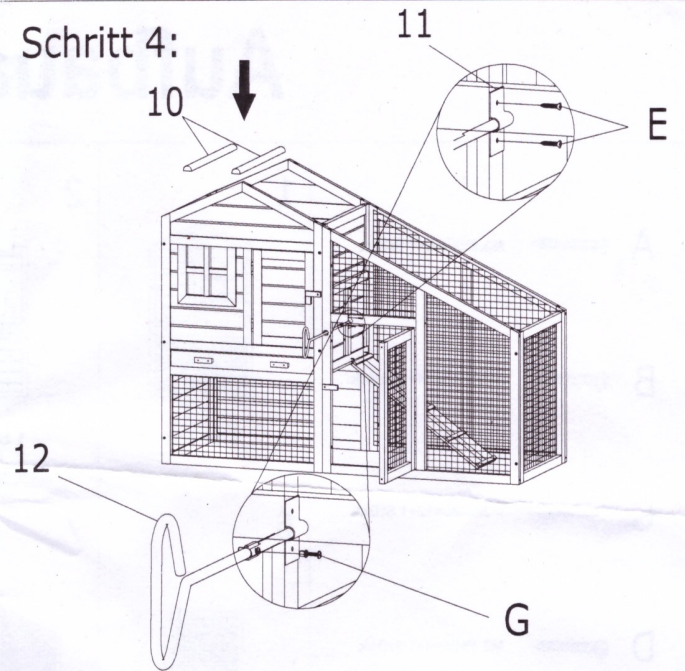

Schritt 5:

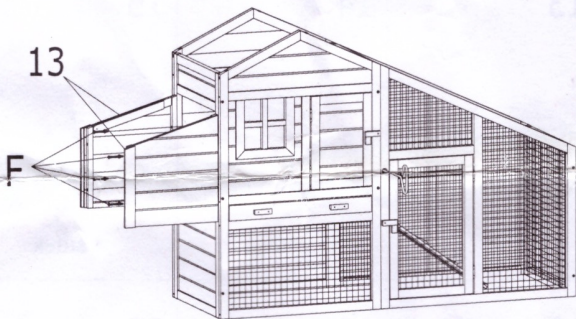

Schritt 6:

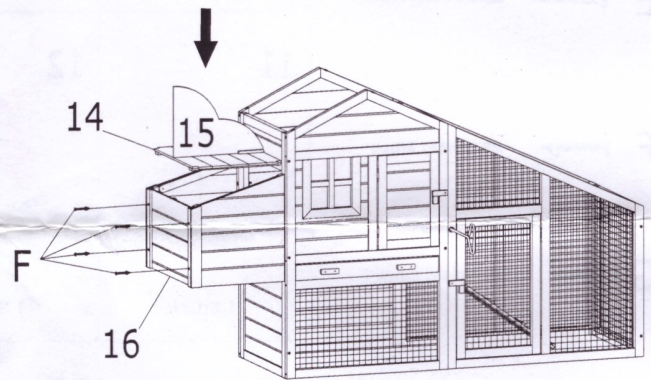

Schritt 7:

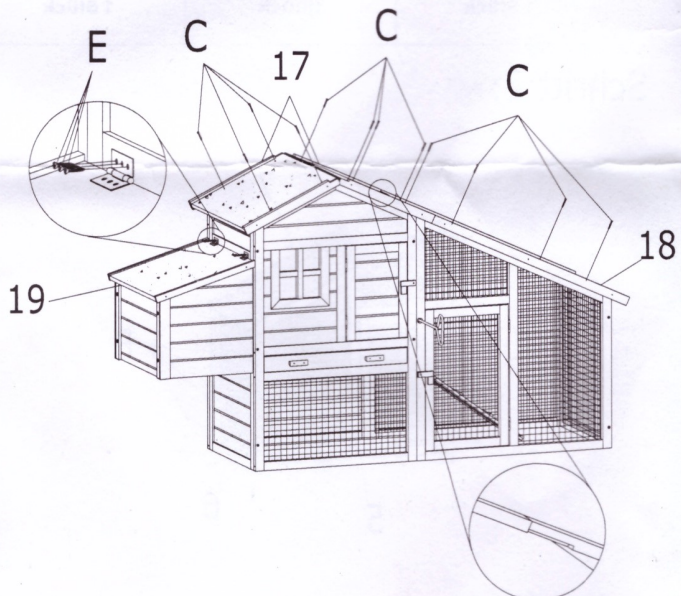

Schritt 8:

